

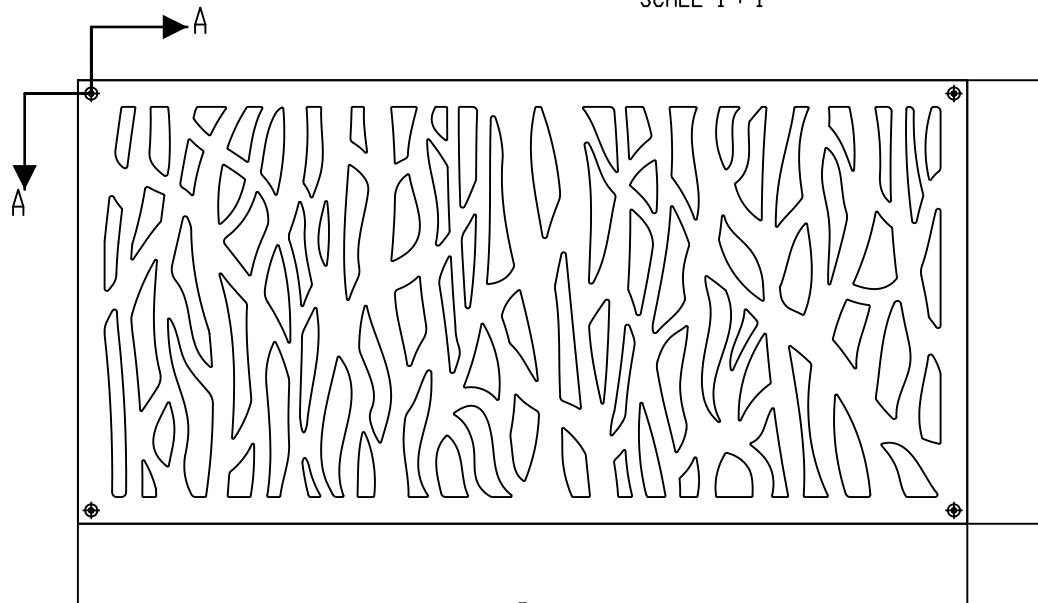

SPRIG DECORATIVE SCREEN PANEL DETAILS

NOTE: FASTENER KIT SOLD SEPARATELY. KIT INCLUDES WOOD SCREWS AND COVERS DESIGNED TO FIT INSIDE RECESS SHOWN FOR CLEAN LOOK.

DIMENSION	2' X 4' PANEL
A	47.70"
B	23.80"

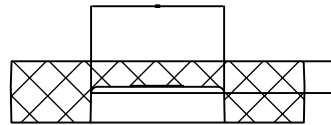
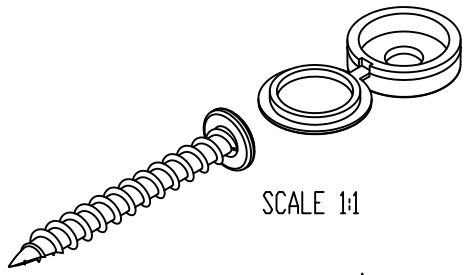

TOLERANCES							
FRACTION	±1/16	DRAWN	C. Kime	DATE	03/11/2022	APPROVED	
XX	±0.01	DESCRIPTION					
XXX	±0.005	SPRIG DECORATIVE SCREEN PANEL 2' X4'					
ANGLE	±1.0°	SHEET 1 OF 11		REVISION	PART NUMBER		
FINISH	125 RMS	SCALE 1:1			N/A		
UNLESS OTHERWISE SPECIFIED		WEIGHT: 9.17					

2	JLG	3/14/2022	N/A	UPDATED DRAWING
1	CMJ	4/9/2020	N/A	UPDATED DRAWING
REV	BY	DATE	PCR	DESCRIPTION



THE INFORMATION CONTAINED IN THIS DRAWING IS PROTECTED BY COPYRIGHT AND PATENT LAWS OF THE UNITED STATES AND OTHER COUNTRIES. ANY REPRODUCTION IN PART OR AS A WHOLE WITHOUT WRITTEN PERMISSION IS PROHIBITED.

MORSE DECORATIVE SCREEN PANEL DETAILS

NOTE: FASTENER KIT SOLD SEPARATELY, KIT INCLUDES WOOD SCREWS AND COVERS DESIGNED TO FIT INSIDE RECESS SHOWN FOR CLEAN LOOK.

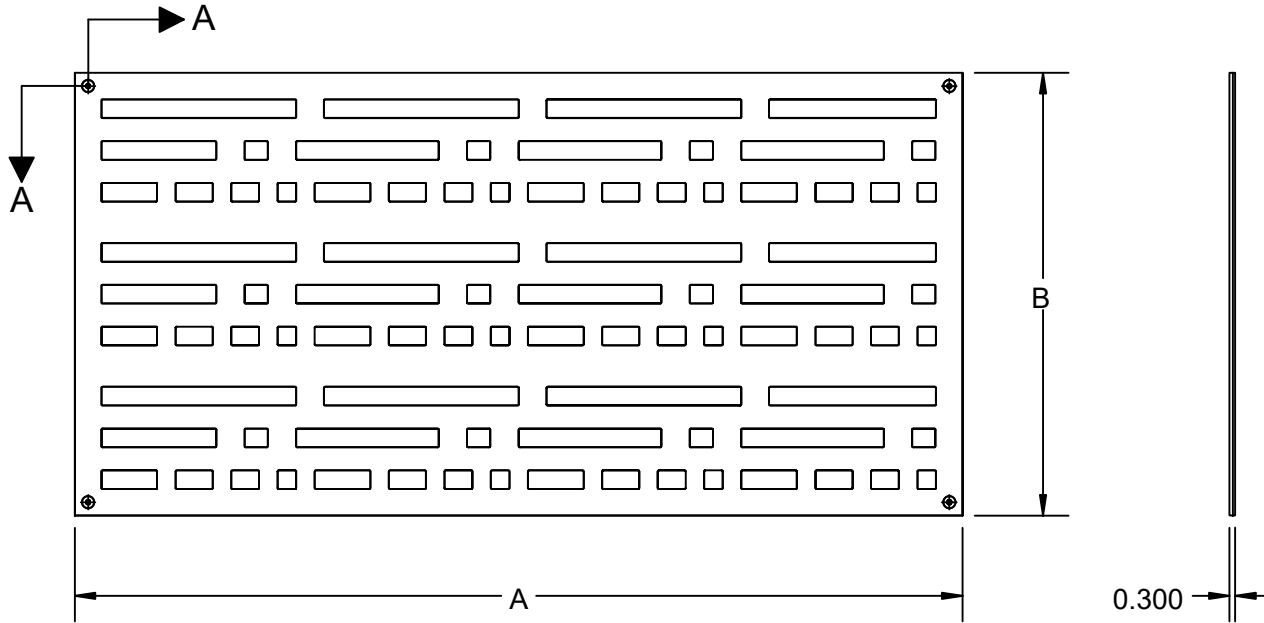
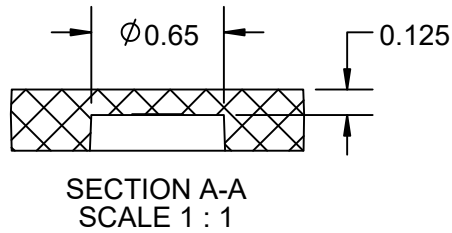
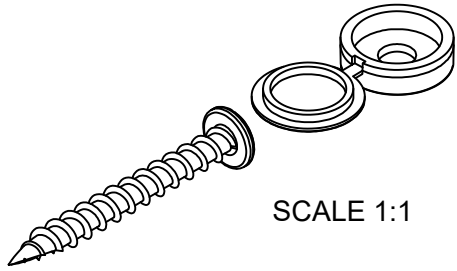
DIMENSION	2' X 4' PANEL
A	47.70"
B	23.80"



TOLERANCES							
FRACTION	± 1/16	DRAWN:	C Kime	DATE:	03/11/2022	APPROVED:	
XX	±0.01	DESCRIPTION:					
XXX	±0.005	MORSE DECORATIVE SCREEN PANEL 2'X4'					
ANGLE	±1.0°	SHEET 2 OF 11		REVISION	PART NUMBER		
FINISH	125 RMS	SCALE 1:11			N/A		
UNLESS OTHERWISE SPECIFIED		WEIGHT: 9.67					

REV	BY	DATE	PCR	DESCRIPTION
2	JLG	3/14/2022	N/A	UPDATED DRAWING
1	CMJ	4/9/2020	N/A	UPDATED DRAWING

THE INFORMATION CONTAINED IN THIS DRAWING IS PROTECTED BY COPYRIGHT AND PATENT LAWS OF THE UNITED STATES AND OTHER COUNTRIES. ANY REPRODUCTION IN PART OR AS A WHOLE WITHOUT WRITTEN PERMISSION IS PROHIBITED.

FRETWORK DECORATIVE SCREEN PANEL DETAILS

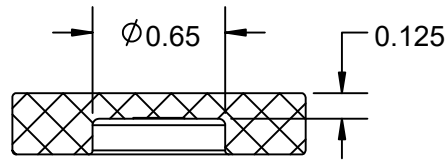
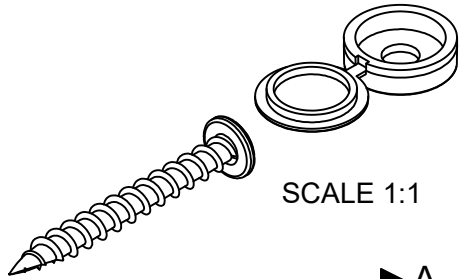

NOTE: FASTENER KIT SOLD SEPARATELY, KIT INCLUDES WOOD SCREWS AND COVERS DESIGNED TO FIT INSIDE RECESS SHOWN FOR CLEAN LOOK.

DIMENSION	2' X 4' PANEL
A	47.70"
B	23.80"

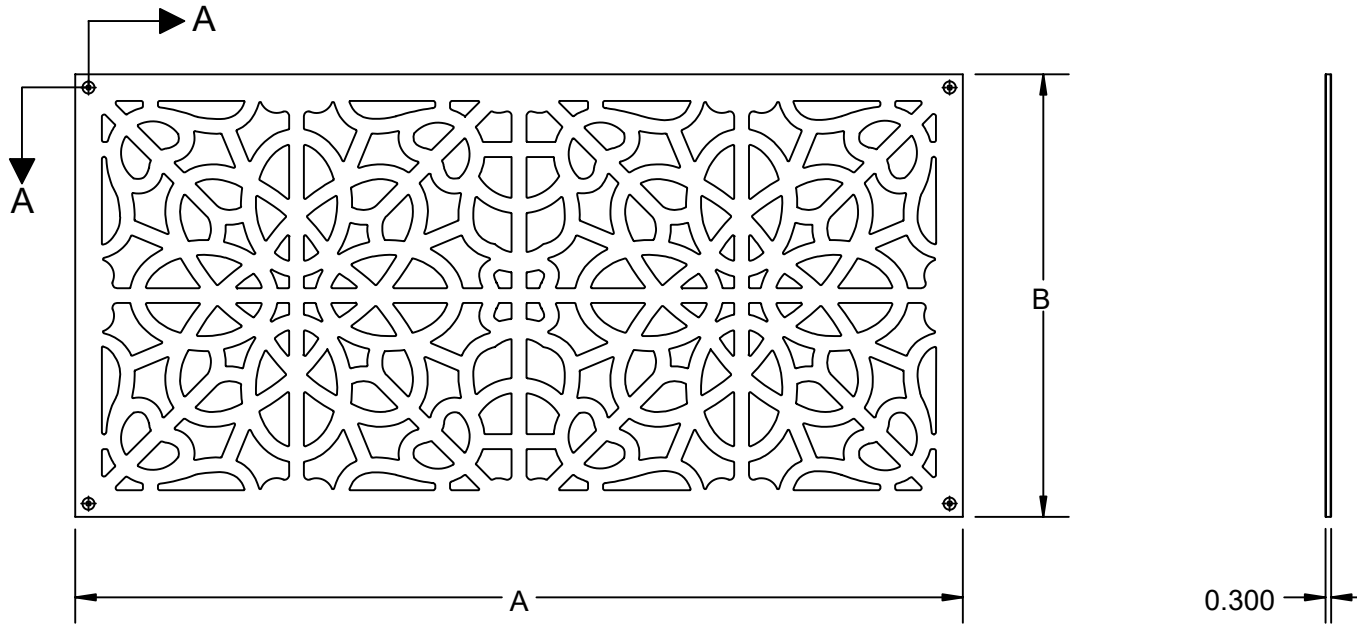

SECTION A-A
SCALE 1 : 1



TOLERANCES							
FRACTION \pm	1/16	DRAWN:	C Kime	DATE:	03/11/2022	APPROVED:	
XX	± 0.01	DESCRIPTION:					
XXX	± 0.005	FRETWORK DECORATIVE SCREEN PANEL 2'X4'					
ANGLE	$\pm 1.0^\circ$	SHEET 3 OF 11		REVISION	PART NUMBER		
FINISH	125 RMS	SCALE 1:11			N/A		
UNLESS OTHERWISE SPECIFIED		WEIGHT: 8.61					

REV	BY	DATE	PCR	DESCRIPTION
2	JLG	3/14/2022	N/A	UPDATED DRAWING
1	CMJ	4/9/2020	N/A	UPDATED DRAWING

THE INFORMATION CONTAINED IN THIS DRAWING IS PROTECTED BY COPYRIGHT AND PATENT LAWS OF THE UNITED STATES AND OTHER COUNTRIES. ANY REPRODUCTION IN PART OR AS A WHOLE WITHOUT WRITTEN PERMISSION IS PROHIBITED.

BOARDWALK DECORATIVE SCREEN PANEL DETAILS

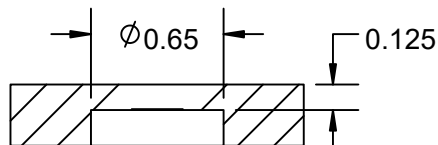
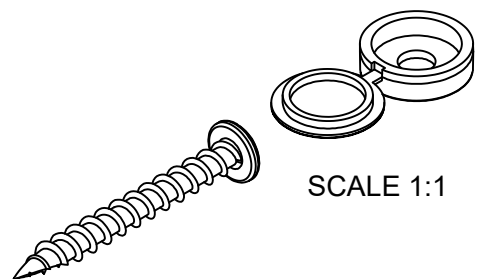

NOTE: FASTENER KIT SOLD SEPARATELY. KIT INCLUDES WOOD SCREWS AND COVERS DESIGNED TO FIT INSIDE RECESS SHOWN (2'X4' ONLY) FOR CLEAN LOOK.

DIMENSION	2' X 4' PANEL	3' X 6' PANEL
A	47.70"	68.00"
B	23.80"	34.00"

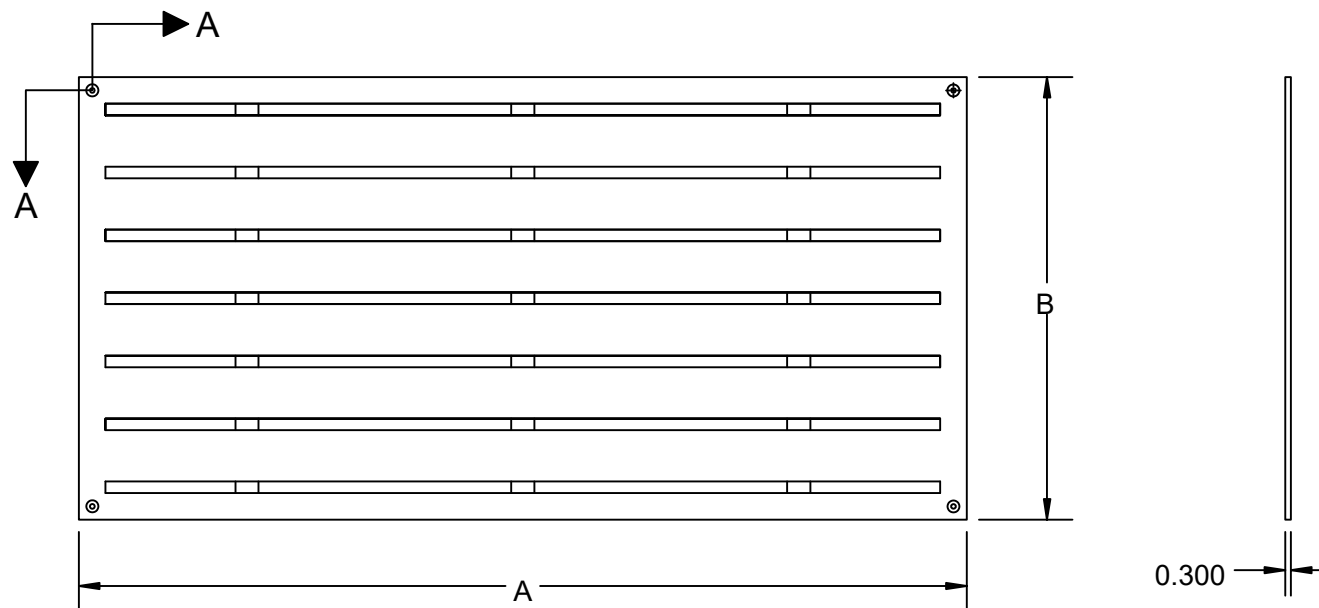

SECTION A-A
SCALE 1:1
(RECESS AVAILABLE ON 2' X 4' PANELS ONLY)



TOLERANCES							
FRACTION	$\pm 1/16$	DRAWN:	C Kime	DATE:	03/11/2022	APPROVED:	
XX	± 0.01	DESCRIPTION: BOARDWAK DECORATIVE SCREEN PANEL					
XXX	± 0.005	SHEET 4 OF 11		REVISION	PART NUMBER		
ANGLE	$\pm 1.0^\circ$	SCALE 1:11			N/A		
FINISH	125 RMS	WEIGHT:					
UNLESS OTHERWISE SPECIFIED							

REV	BY	DATE	PCR	DESCRIPTION
2	JLG	3/4/2022	N/A	UPDATED DRAWING
1	CMJ	4/9/2020	N/A	UPDATED DRAWING



THE INFORMATION CONTAINED IN THIS DRAWING IS PROTECTED BY COPYRIGHT AND PATENT LAWS OF THE UNITED STATES AND OTHER COUNTRIES. ANY REPRODUCTION IN PART OR AS A WHOLE WITHOUT WRITTEN PERMISSION IS PROHIBITED.

RIVER ROCK DECORATIVE SCREEN PANEL DETAILS

NOTE: FASTENER KIT SOLD SEPARATELY. KIT INCLUDES WOOD SCREWS AND COVERS FOR CLEAN FINISHED LOOK.

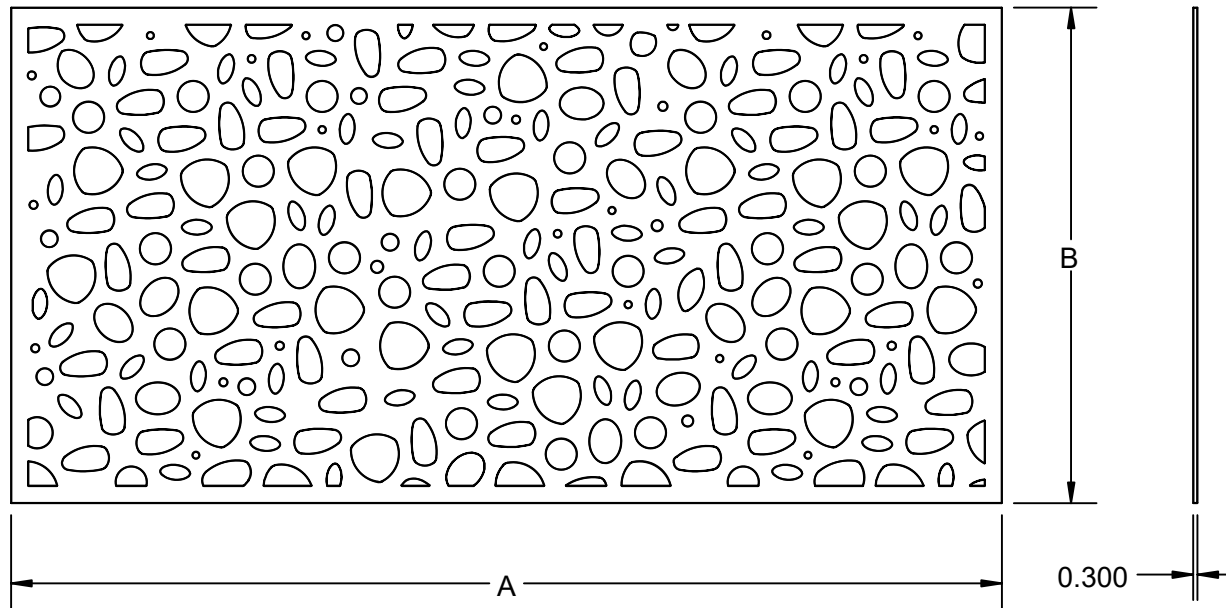
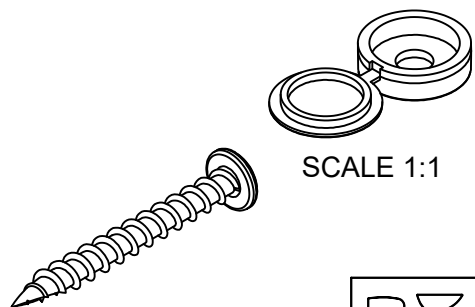
DIMENSION	3' X 6' PANEL
A	68.00"
B	34.00"



TOLERANCES							
FRACTION	± 1/16	DRAWN:	L GONZALEZ	DATE:	03/04/2022	APPROVED:	
XX	±0.01	DESCRIPTION: RIVER ROCK DECORATIVE SCREEN PANEL					
XXX	±0.005	SHEET 5 OF 11					
ANGLE	±1.0°	SCALE 1:11					
FINISH	125 RMS	WEIGHT:					
UNLESS OTHERWISE SPECIFIED				PART NUMBER: N/A			

THE INFORMATION CONTAINED IN THIS DRAWING IS PROTECTED BY COPYRIGHT AND PATENT LAWS OF THE UNITED STATES AND OTHER COUNTRIES. ANY REPRODUCTION IN PART OR AS A WHOLE WITHOUT WRITTEN PERMISSION IS PROHIBITED.



REV	BY	DATE	PCR	DESCRIPTION

OPTIC DECORATIVE SCREEN PANEL DETAILS

NOTE: FASTENER KIT SOLD SEPARATELY. KIT INCLUDES WOOD SCREWS AND COVERS FOR CLEAN FINISHED LOOK.

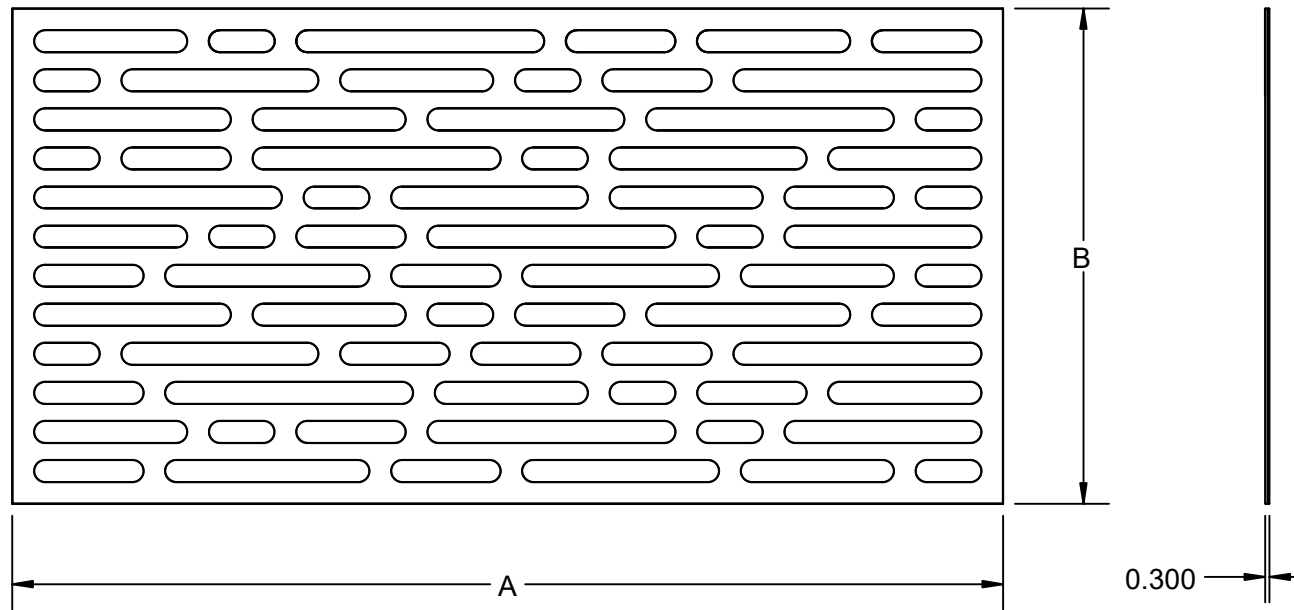
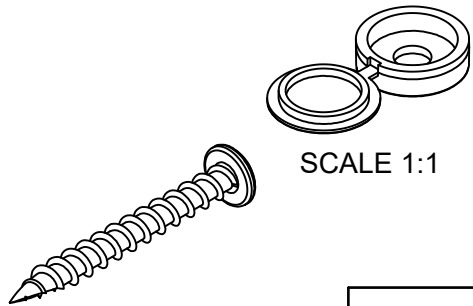
DIMENSION	3' X 6' PANEL
A	68.00"
B	34.00"



TOLERANCES							
FRACTION	± 1/16	DRAWN:	L GONZALEZ	DATE:	03/04/2022	APPROVED:	
XX	±0.01	DESCRIPTION: OPTIC DECORATIVE SCREEN PANEL					
XXX	±0.005	SHEET 6 OF 11					
ANGLE	±1.0°	SCALE 1:11					
FINISH	125 RMS	WEIGHT: 12.40					
UNLESS OTHERWISE SPECIFIED				PART NUMBER N/A			

REV	BY	DATE	PCR	DESCRIPTION

THE INFORMATION CONTAINED IN THIS DRAWING IS PROTECTED BY COPYRIGHT AND PATENT LAWS OF THE UNITED STATES AND OTHER COUNTRIES. ANY REPRODUCTION IN PART OR AS A WHOLE WITHOUT WRITTEN PERMISSION IS PROHIBITED.

SANIBEL DECORATIVE SCREEN PANEL DETAILS

NOTE: FASTENER KIT SOLD SEPARATELY. KIT INCLUDES WOOD SCREWS AND COVERS FOR CLEAN FINISHED LOOK.

DIMENSION	2' X 4' PANEL	3' X 6' PANEL
A	47.88"	68.00"
B	23.88"	34.00"

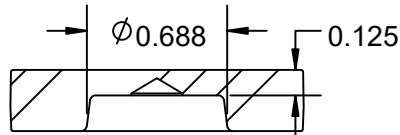

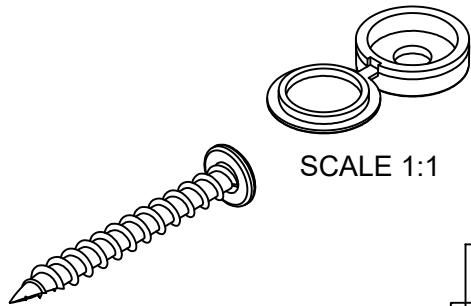

SECTION A-A
SCALE 1 : 1
(RECESS AVAILABLE ON 2' X 4' PANELS ONLY)

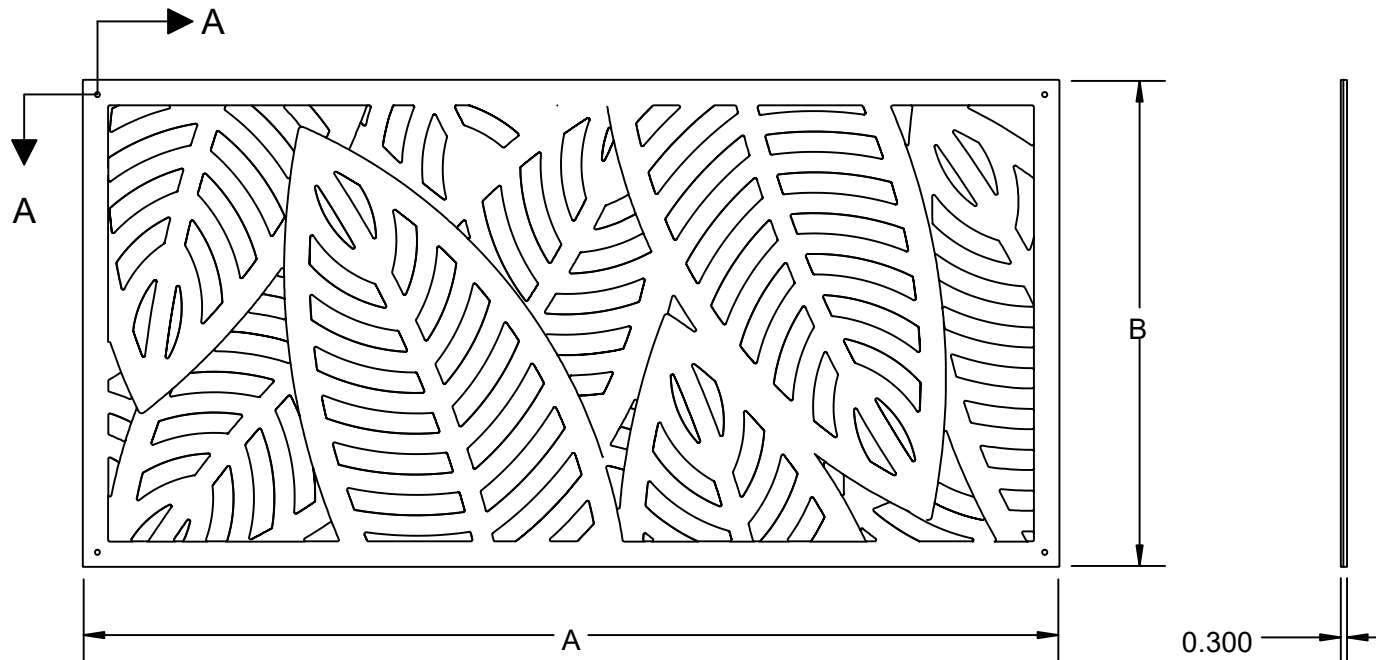

SCALE 1:1



TOLERANCES							
FRACTION \pm	1/16	DRAWN:	L GONZALEZ	DATE:	03/04/2022	APPROVED:	
XX	± 0.01	DESCRIPTION: SANIBEL DECORATIVE SCREEN PANEL					
XXX	± 0.005	SHEET 7 OF 11		REVISION	PART NUMBER		
ANGLE	$\pm 1.0^\circ$	SCALE 1:11			N/A		
FINISH	125 RMS	WEIGHT: 0.001					
UNLESS OTHERWISE SPECIFIED							

REV	BY	DATE	PCR	DESCRIPTION

THE INFORMATION CONTAINED IN THIS DRAWING IS PROTECTED BY COPYRIGHT AND PATENT LAWS OF THE UNITED STATES AND OTHER COUNTRIES. ANY REPRODUCTION IN PART OR AS A WHOLE WITHOUT WRITTEN PERMISSION IS PROHIBITED.

SLATE DECORATIVE SCREEN PANEL DETAILS

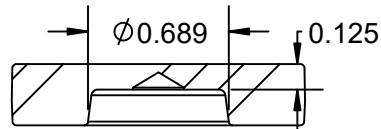
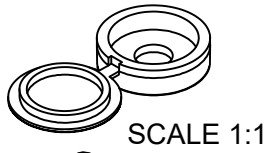

NOTE: FASTENER KIT SOLD SEPARATELY. KIT INCLUDES WOOD SCREWS AND COVERS FOR CLEAN FINISHED LOOK.

DIMENSION	2' X 4' PANEL
A	47.88"
B	23.88"

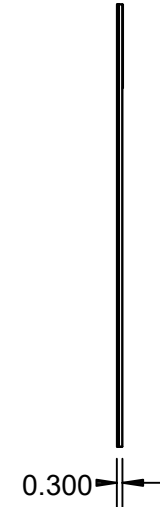
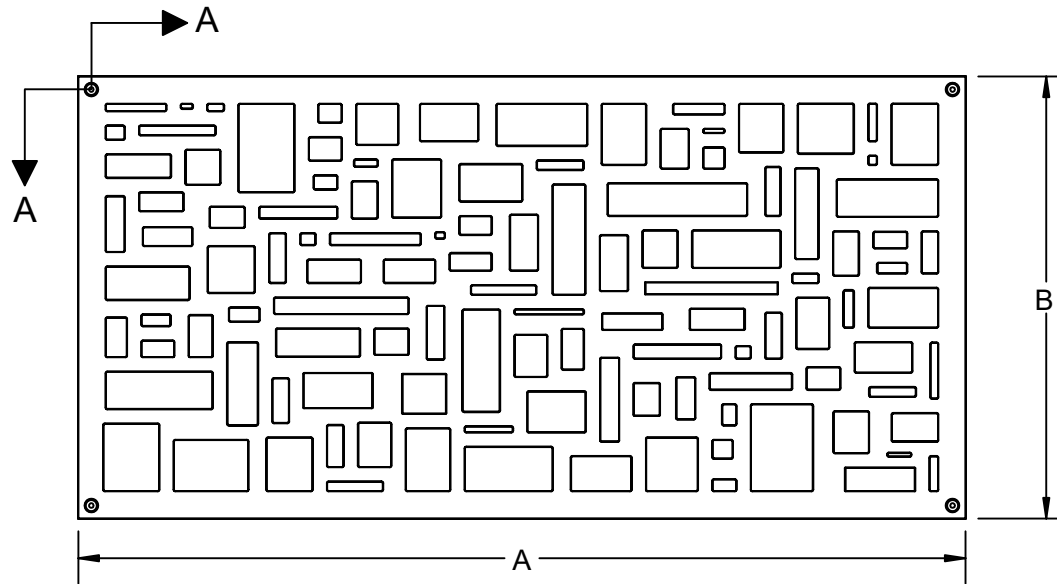
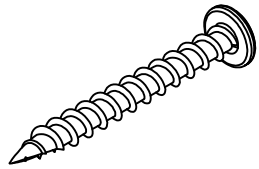

SECTION A-A
SCALE 1 : 1



TOLERANCES							
FRACTION	$\pm 1/16$	DRAWN:	L GONZALEZ	DATE:	03/04/2022	APPROVED:	
XX	± 0.01	DESCRIPTION: SLATE DECORATIVE SCREEN PANEL					
XXX	± 0.005	SHEET 8 OF 11					
ANGLE	$\pm 1.0^\circ$	SCALE 1:11					
FINISH	125 RMS	WEIGHT: 6.33					
UNLESS OTHERWISE SPECIFIED				PART NUMBER: N/A			

REV	BY	DATE	PCR	DESCRIPTION

THE INFORMATION CONTAINED IN THIS DRAWING IS PROTECTED BY COPYRIGHT AND PATENT LAWS OF THE UNITED STATES AND OTHER COUNTRIES. ANY REPRODUCTION IN PART OR AS A WHOLE WITHOUT WRITTEN PERMISSION IS PROHIBITED.

2' X 4' DECORATIVE SCREEN PANEL FRAME KIT DETAILS

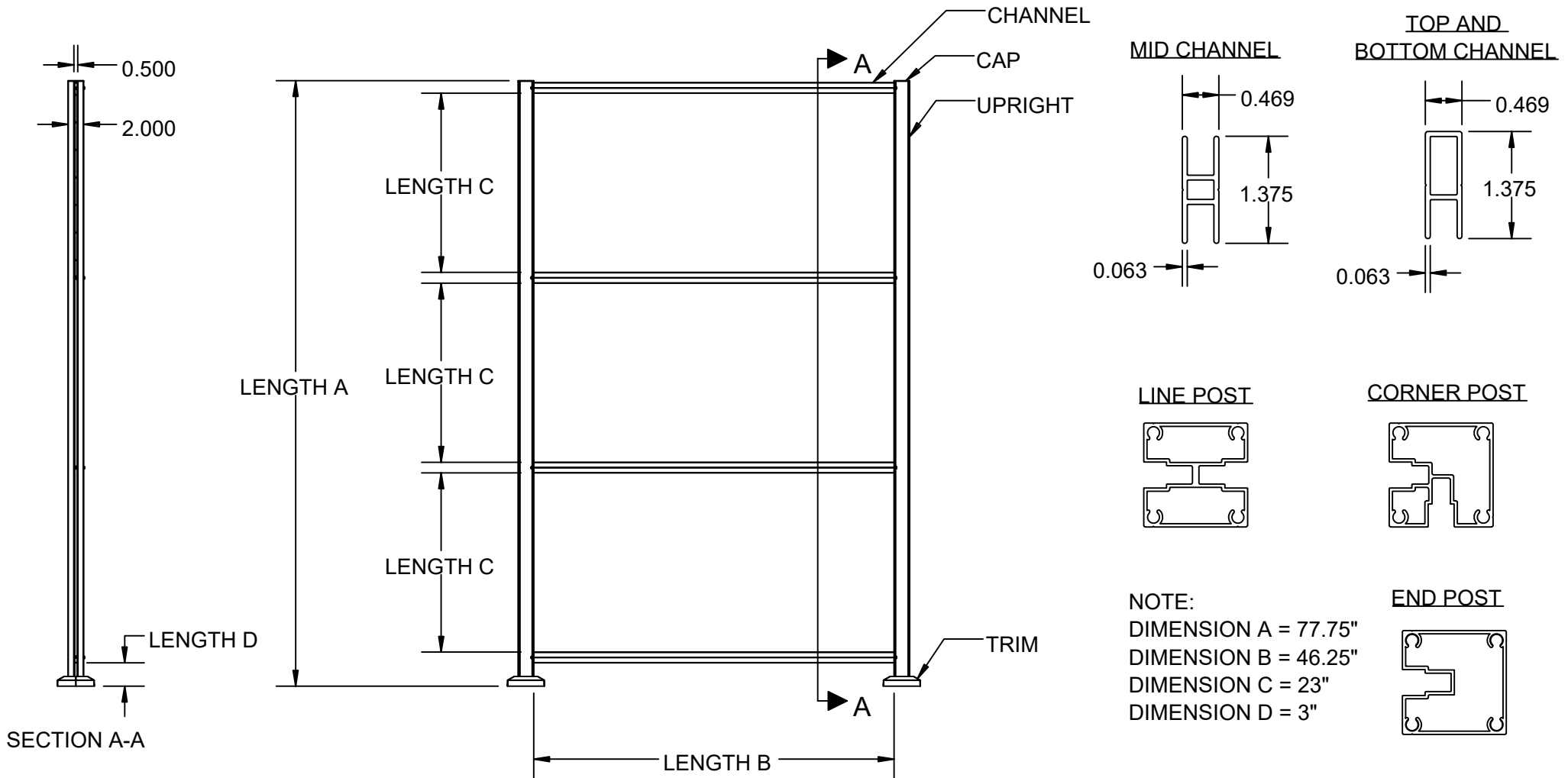

NOTE:

1. DECORATIVE SCREEN PANEL (DSP) KITS CAN HOLD 1-3 PANELS (SOLD SEPARATELY).
2. USE 2'X4' PANELS.

TOLERANCES			
FRACTION ± 1/16		DRAWN: C Kime	DATE: 03/11/2022
XX	±0.01	APPROVED:	
XXX	±0.005	DESCRIPTION: DECORATIVE SCREEN PANEL KIT DETAILS	
ANGLE	±1.0°	SHEET 9 OF 11	REVISION:
FINISH	125 RMS	SCALE 1:20	PART NUMBER: N/A
UNLESS OTHERWISE SPECIFIED		WEIGHT:	

THE INFORMATION CONTAINED IN THIS DRAWING IS PROTECTED BY COPYRIGHT AND PATENT LAWS OF THE UNITED STATES AND OTHER COUNTRIES. ANY REPRODUCTION IN PART OR AS A WHOLE WITHOUT WRITTEN PERMISSION IS PROHIBITED.

REV	BY	DATE	PCR	DESCRIPTION
2	JLG	3/4/2022	N/A	UPDATED DRAWING
1	CMJ	4/9/2020	N/A	UPDATED DRAWING