

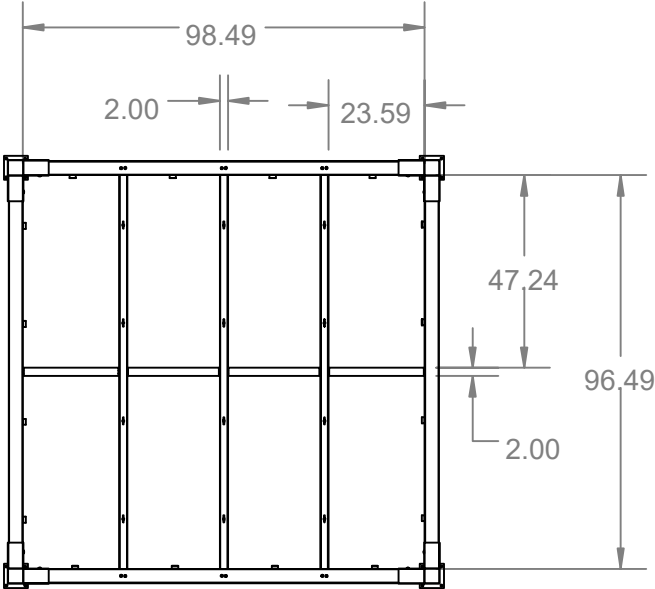

PERGOLA DETAILS

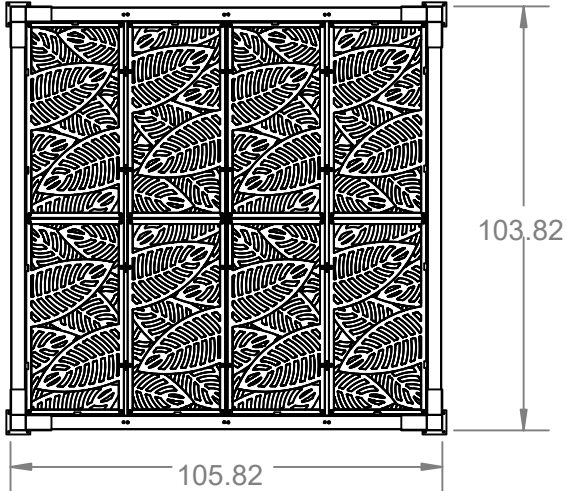

ROOF DETAILS

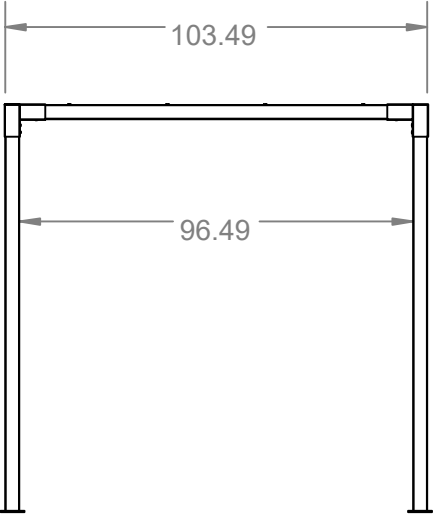
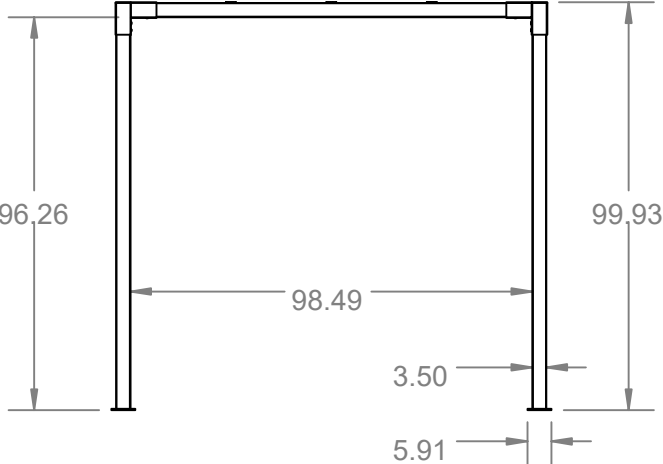

THE INFORMATION CONTAINED IN THIS DRAWING IS PROTECTED BY COPYRIGHT AND PATENT LAWS OF THE UNITED STATES AND OTHER COUNTRIES. ANY REPRODUCTION IN PART OR AS A WHOLE WITHOUT WRITTEN PERMISSION IS PROHIBITED.

		
DRAWN: EP	DATE: 02/08/2023	APPROVED:
DESCRIPTION: PERGOLA DETAILS		
SHEET 1 OF 4	REVISION	PART NUMBER
SCALE 1:50		N/A
WEIGHT: 162.63		

PERGOLA PROFILES

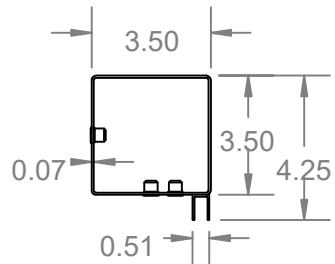

ROOF BEAM

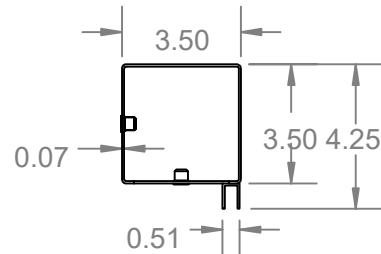

ROOF BEAM W/
JOIST CUTOUTS

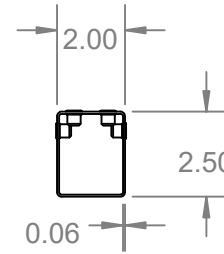

ROOF JOIST

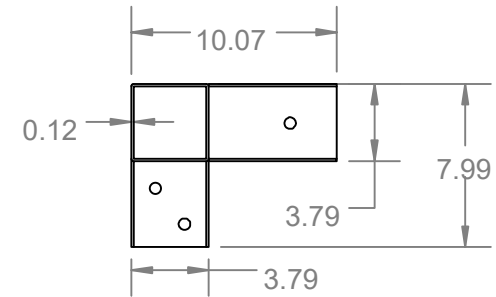
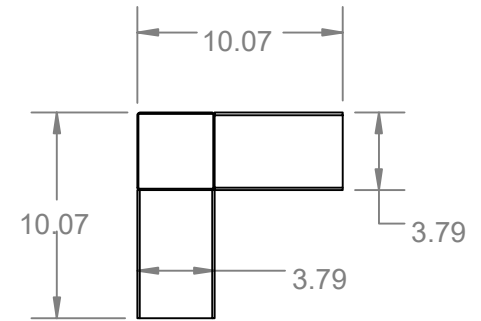

CORNER BRACE

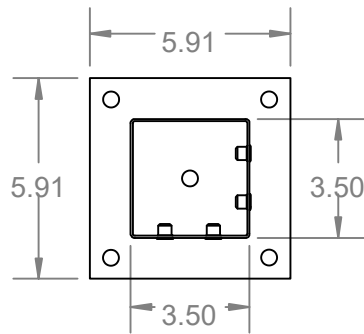

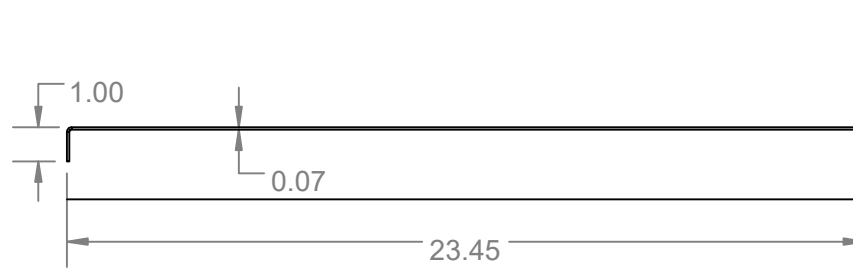

POST

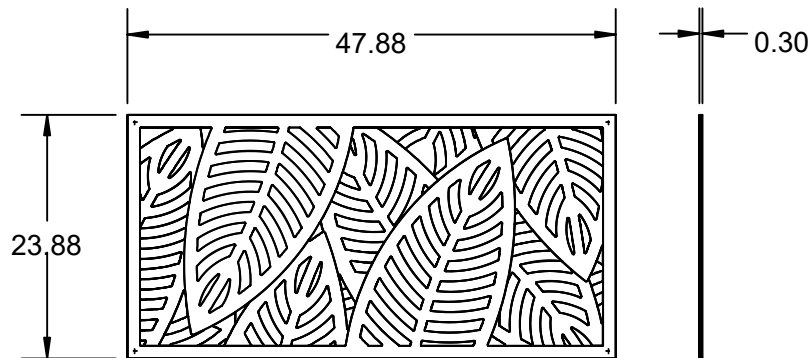

DSP MID SUPPORT



DSP BOARD

		
DRAWN: EP	DATE: 02/08/2023	APPROVED:
DESCRIPTION: PERGOLA PROFILES		
SHEET 2 OF 4	REVISION	PART NUMBER
SCALE 1:20		N/A
WEIGHT: 8.36		

THE INFORMATION CONTAINED IN THIS DRAWING IS PROTECTED BY COPYRIGHT AND PATENT LAWS OF THE UNITED STATES AND OTHER COUNTRIES. ANY REPRODUCTION IN PART OR AS A WHOLE WITHOUT WRITTEN PERMISSION IS PROHIBITED.

PERGOLA WALL DETAILS

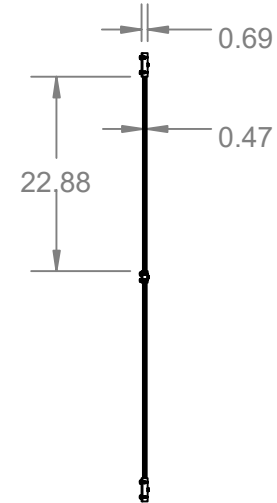
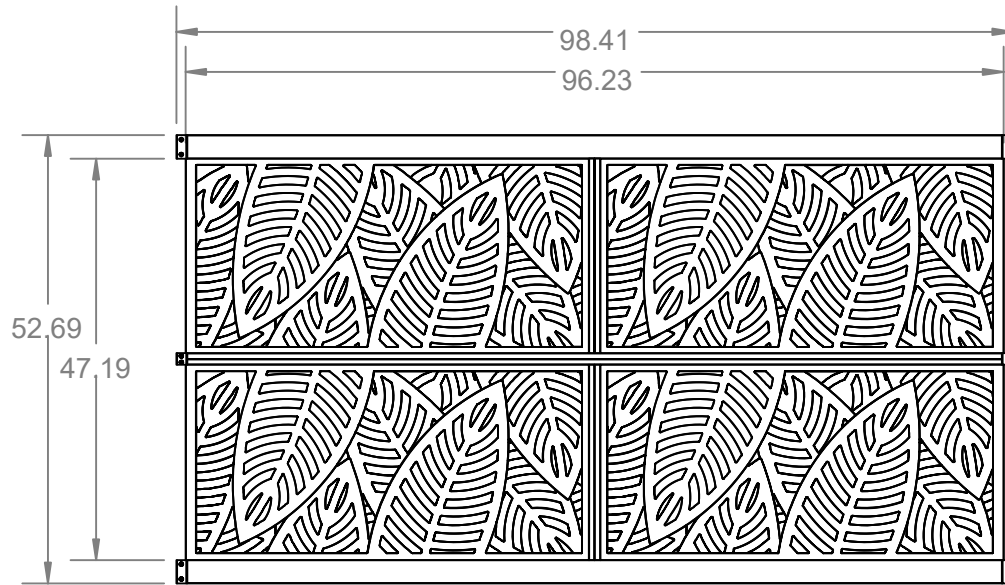

PERGOLA WALL PROFILES

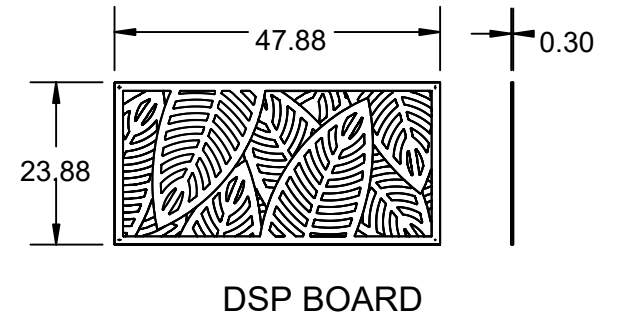
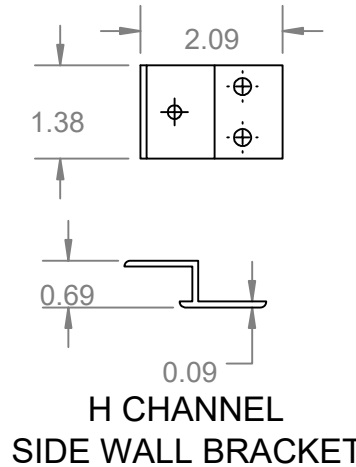
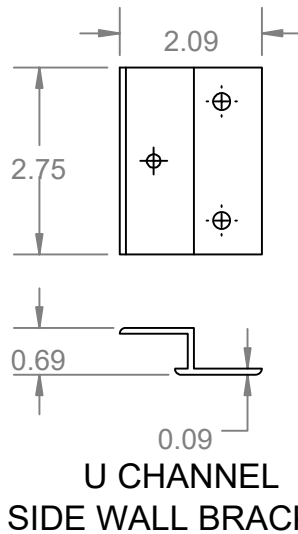
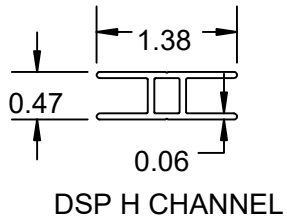
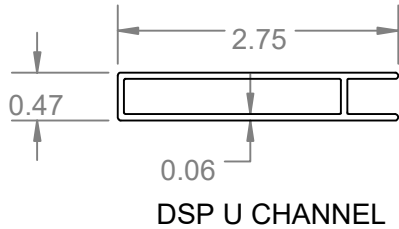

THE INFORMATION CONTAINED IN THIS DRAWING IS PROTECTED BY COPYRIGHT AND PATENT LAWS OF THE UNITED STATES AND OTHER COUNTRIES. ANY REPRODUCTION IN PART OR AS A WHOLE WITHOUT WRITTEN PERMISSION IS PROHIBITED.

rdi RAILING		
DRAWN: EP	DATE: 02/08/2023	APPROVED:
DESCRIPTION: PERGOLA WALL DETAILS		
SHEET 3 OF 4	REVISION	PART NUMBER
SCALE 1:24	0	N/A
WEIGHT: 36.81		

PERGOLA POST AND SURFACE MOUNT DETAILS

NOTE: IMAGES ONLY REFERENCE 2" AND 2.5" POSTS.

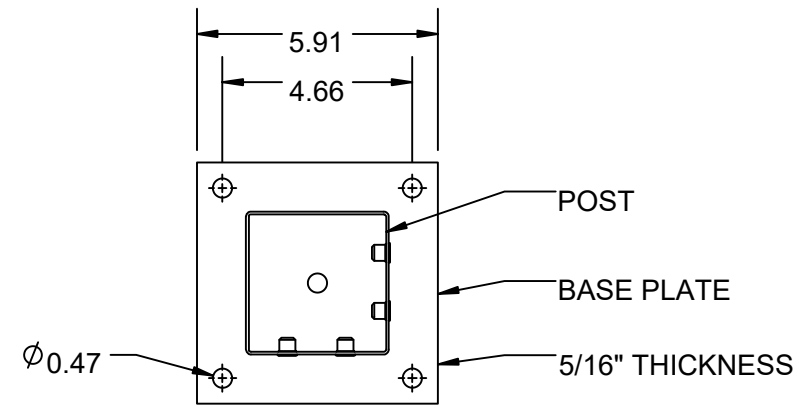

POST BASE CONNECTION INTO WOOD WITH THROUGH BOLTS

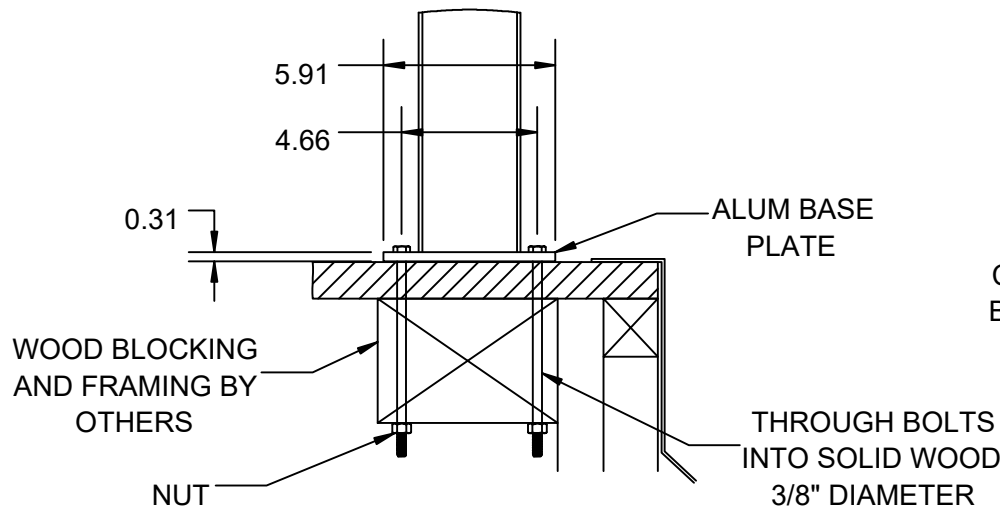

POST BASE CONNECTION INTO CONCRETE WITH WEDGE ANCHORS

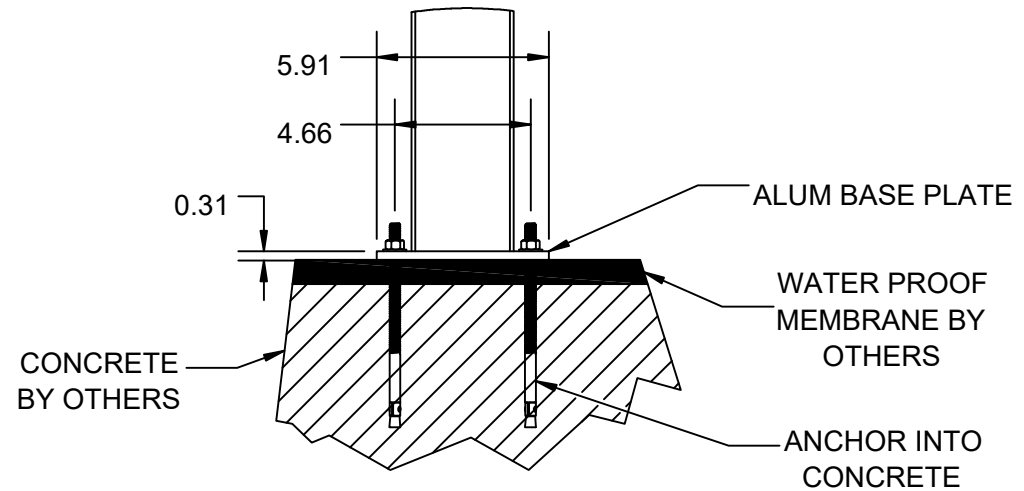

NOTE:

1. COMMERCIAL APPLICATIONS ARE ALWAYS BOLTED, USE 3/8" DIAMETER A307 THROUGH BOLTS INTO SOLID WOOD BLOCKING.
2. WOOD BLOCKING BY OTHERS.
3. BLOCKING MUST BE DESIGNED TO WITHSTAND PROPER LOADING.

THE INFORMATION CONTAINED IN THIS DRAWING IS PROTECTED BY COPYRIGHT AND PATENT LAWS OF THE UNITED STATES AND OTHER COUNTRIES. ANY REPRODUCTION IN PART OR AS A WHOLE WITHOUT WRITTEN PERMISSION IS PROHIBITED.

DRAWN: EP	DATE: 02/08/2023	APPROVED:
DESCRIPTION: PERGOLA POST AND SURFACE MOUNT DETAIL		
SHEET 4 OF 4	REVISION	PART NUMBER
SCALE 1:16		N/A
WEIGHT: N/A		